



Is Now Part of



ON Semiconductor®

To learn more about ON Semiconductor, please visit our website at
www.onsemi.com

ON Semiconductor and the ON Semiconductor logo are trademarks of Semiconductor Components Industries, LLC dba ON Semiconductor or its subsidiaries in the United States and/or other countries. ON Semiconductor owns the rights to a number of patents, trademarks, copyrights, trade secrets, and other intellectual property. A listing of ON Semiconductor's product/patent coverage may be accessed at www.onsemi.com/site/pdf/Patent-Marking.pdf. ON Semiconductor reserves the right to make changes without further notice to any products herein. ON Semiconductor makes no warranty, representation or guarantee regarding the suitability of its products for any particular purpose, nor does ON Semiconductor assume any liability arising out of the application or use of any product or circuit, and specifically disclaims any and all liability, including without limitation special, consequential or incidental damages. Buyer is responsible for its products and applications using ON Semiconductor products, including compliance with all laws, regulations and safety requirements or standards, regardless of any support or applications information provided by ON Semiconductor. "Typical" parameters which may be provided in ON Semiconductor data sheets and/or specifications can and do vary in different applications and actual performance may vary over time. All operating parameters, including "Typicals" must be validated for each customer application by customer's technical experts. ON Semiconductor does not convey any license under its patent rights nor the rights of others. ON Semiconductor products are not designed, intended, or authorized for use as a critical component in life support systems or any FDA Class 3 medical devices or medical devices with a same or similar classification in a foreign jurisdiction or any devices intended for implantation in the human body. Should Buyer purchase or use ON Semiconductor products for any such unintended or unauthorized application, Buyer shall indemnify and hold ON Semiconductor and its officers, employees, subsidiaries, affiliates, and distributors harmless against all claims, costs, damages, and expenses, and reasonable attorney fees arising out of, directly or indirectly, any claim of personal injury or death associated with such unintended or unauthorized use, even if such claim alleges that ON Semiconductor was negligent regarding the design or manufacture of the part. ON Semiconductor is an Equal Opportunity/Affirmative Action Employer. This literature is subject to all applicable copyright laws and is not for resale in any manner.



FPF1205 / FPF1206 IntelliMAX™ Advanced Load Switch

Features

- 1.2 V to 4.0 V Input Voltage Operating Range
- Typical R_{ON} : 75 m Ω at $V_{IN}=3.3$ V
110 m Ω at $V_{IN}=1.8$ V
240 m Ω at $V_{IN}=1.2$ V
- Slew Rate Control with t_R : 110 μ s
- Output Discharge Function on FPF1206
- Low <1.5 μ A Quiescent Current
- Extra Low <100 nA Off Supply Current
- ESD Protected: Above 7000 V HBM, 2000 V CDM
- GPIO/CMOS-Compatible Enable Circuitry
- 4-Bump WLCSP, 0.76 mm x 0.76 mm, 0.4 mm Pitch

Applications

- Mobile Devices and Smart Phones
- Portable Media Devices
- Ultra-Portable / Mobile Computing
- Advanced Notebook, UMPC, MID
- Portable Medical Devices
- GPS and Navigation Equipment

Description

The FPF1205/06 is an ultra-small IntelliMAX™ load switch with integrated P-channel switch and analog control features. Internal slew-rate control prevents inrush current and the resulting excessive voltage drop on power rail. The input voltage range operates from 1.2 V to 4.0 V to provide power-disconnect capability for post-regulated power rails in portable and consumer products. The low shut-off current of 1 μ A (maximum) allows power designs to meet standby and off-power drain specifications.

The FPF1205/06 is controlled by an active-HIGH logic input (ON pin) compatible with standard CMOS GPIO circuitry found on Field Programmable Gate Array (FPGA) and embedded processors. The FPF1205/06 is available in a 0.76 mm x 0.76 mm 4-bump Wafer-Level Chip-Scale Package (WLCSP).

Ordering Information

Part Number	Top Marking	Switch (Typical) at 3.3 V_{IN}	Output Discharge	ON Pin Activity	t_R	Package
FPF1205UCX	QJ	75 m Ω	NA	Active HIGH	110 μ s	4-Ball WLCSP, 0.76 mm x 0.76 mm, 0.4 mm Pitch
FPF1206UCX	QK	75 m Ω	6 5 Ω	Active HIGH	110 μ s	

Application Diagram

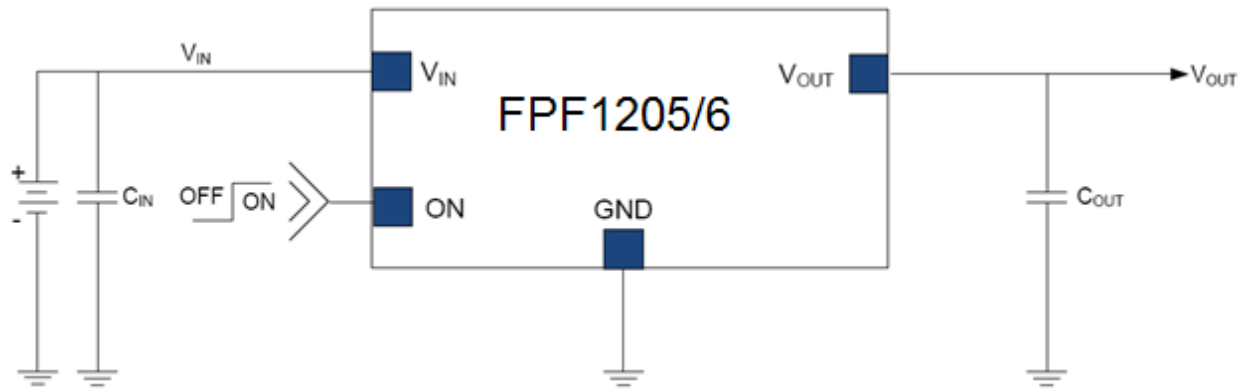

Figure 1. Typical Application

Notes:

1. $C_{IN}=1 \mu F$, X5R, 0603 (for example, Murata GRM185R60J105KE26).
2. $C_{OUT}=0.1 \mu F$, X5R, 0805 (for example, Murata GRM216R61A105KA01).

Functional Block Diagram

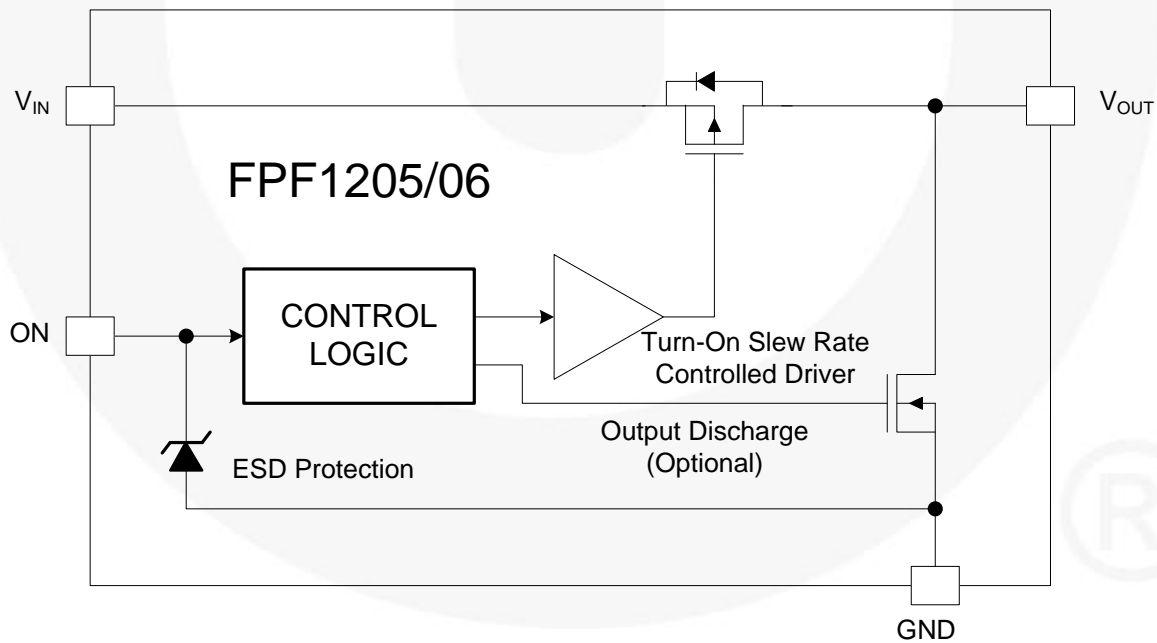

Figure 2. Functional Block Diagram (Output Discharge for FPF1206 Only)

Pin Configurations

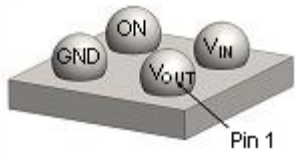

Figure 3. WLCSP Bumps Facing Up (Top View)

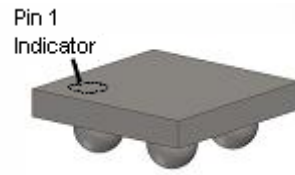

Figure 4. WLCSP Bumps Facing Down (Bottom View)

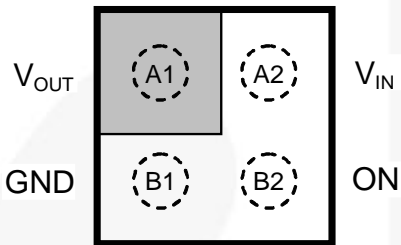

Figure 5. Pin Assignments (Top View)

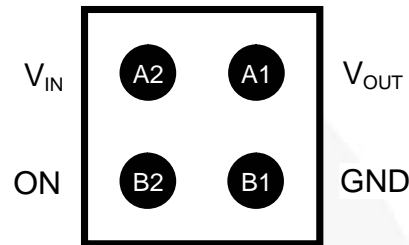

Figure 6. Pin Assignments (Bottom View)

Pin Definitions

Pin #	Name	Description
A1	V _{OUT}	Switch Output
A2	V _{IN}	Supply Input, Input to the power switch
B1	GND	Ground
B2	ON	ON/OFF control, active HIGH

Absolute Maximum Ratings

Stresses exceeding the absolute maximum ratings may damage the device. The device may not function or be operable above the recommended operating conditions and stressing the parts to these levels is not recommended. In addition, extended exposure to stresses above the recommended operating conditions may affect device reliability. The absolute maximum ratings are stress ratings only.

Symbol	Parameter	Min.	Max.	Unit	
V_{IN}	V_{IN} , V_{OUT} , V_{ON} to GND	-0.3	4.2	V	
I_{SW}	Maximum Continuous Switch Current		1.2	A	
P_D	Power Dissipation at $T_A=25^\circ\text{C}$		1.0	W	
T_{STG}	Storage Junction Temperature	-65	+150	$^\circ\text{C}$	
T_A	Operating Temperature Range	-40	+85	$^\circ\text{C}$	
Θ_{JA}	Thermal Resistance, Junction-to-Ambient	1S2P with One Thermal Via		110	$^\circ\text{C}/\text{W}$
		1S2P without Thermal Via		95	
ESD	Electrostatic Discharge Capability ^(3,4)	Human Body Model, JESD22-A114	7		kV
		Charged Device Model, JESD22-C101	2		

Notes:

3. Measured using 2S2P JEDEC std. PCB.
4. Measured using 2S2P JEDEC PCB COLD PLATE Method.

Recommended Operating Conditions

The Recommended Operating Conditions table defines the conditions for actual device operation. Recommended operating conditions are specified to ensure optimal performance to the datasheet specifications. Fairchild does not recommend exceeding them or designing to Absolute Maximum Ratings.

Symbol	Parameter	Min.	Max.	Unit
V_{IN}	Supply Voltage	1.2	4.0	V
T_A	Ambient Operating Temperature	-40	+85	$^\circ\text{C}$

Electrical Characteristics

Unless otherwise noted, $V_{IN}=1.2$ to 4.0 V and $T_A=-40$ to $+85^\circ\text{C}$. Typical values are at $V_{IN}=3.3$ V and $T_A=25^\circ\text{C}$.

Symbol	Parameter	Conditions	Min.	Typ.	Max.	Unit
Basic Operation						
V_{IN}	Supply Voltage		1.2		4.0	V
$I_{Q(OFF)}$	Off Supply Current	$V_{ON}=GND$, $V_{OUT}=Open$, $V_{IN}=4$ V			100	nA
I_{SD}	Shutdown Current	$V_{ON}=GND$, $V_{OUT}=GND$			1	μA
I_Q	Quiescent Current	$I_{OUT}=0$ mA			1.5	μA
R_{ON}	On Resistance	$V_{IN}=3.3$ V, $I_{OUT}=200$ mA, $T_A=25^\circ\text{C}$		75	100	m Ω
		$V_{IN}=1.8$ V, $I_{OUT}=200$ mA, $T_A=25^\circ\text{C}$		110	150	
		$V_{IN}=1.2$ V, $I_{OUT}=200$ mA, $T_A=25^\circ\text{C}$		240	300	
		$V_{IN}=1.8$ V, $I_{OUT}=200$ mA, $T_A=85^\circ\text{C}$		160	200	
R_{PD}	Output Discharge $R_{PULL\ DOWN}$	$V_{IN}=3.3$ V, $V_{ON}=0$ V, $I_{FORCE}=20$ mA, $T_A=25^\circ\text{C}$, FPF1206		65	110	Ω
V_{IH}	On Input Logic HIGH Voltage	$V_{IN} < 1.5$ V	0.9			V
		$V_{IN}=1.5$ V to 4.0 V	1.1			
V_{IL}	On Input Logic LOW Voltage	$V_{IN}=1.2$ V to 4.0 V			0.75	V
I_{ON}	On Input Leakage	$V_{ON}=V_{IN}$ or GND			1	μA
Dynamic Characteristics⁽⁵⁾						
t_{DON}	Turn-On Delay ⁽⁶⁾	$V_{IN}=3.3$ V, $R_L=10$ Ω , $C_L=0.1$ μF , $T_A=25^\circ\text{C}$		110		μs
t_R	V_{OUT} Rise Time ⁽⁶⁾			110		
t_{ON}	Turn-On Time ⁽⁶⁾			220		
t_{DOFF}	Turn-Off Delay ⁽⁶⁾	$V_{IN}=3.3$ V, $R_L=10$ Ω , $C_L=0.1$ μF , $T_A=25^\circ\text{C}$, FPF1205		7		μs
t_F	V_{OUT} Fall Time ⁽⁶⁾			2		
t_{OFF}	Turn-Off Time ⁽⁶⁾			9		
t_{DOFF}	Turn-Off Delay	$V_{IN}=3.3$ V, $R_L=500$ Ω , $C_L=0.1$ μF , $T_A=25^\circ\text{C}$, FPF1205		10		μs
t_F	V_{OUT} Fall Time			95		
t_{OFF}	Turn-Off Time ⁽⁶⁾			105		
t_{DOFF}	Turn-Off Delay	$V_{IN}=3.3$ V, $R_L=500$ Ω , $C_L=0.1$ μF , $T_A=25^\circ\text{C}$, FPF1206 ⁽⁷⁾		7.0		μs
t_F	V_{OUT} Fall Time			10.5		
t_{OFF}	Turn-Off Time ⁽⁶⁾			17.5		

Notes:

- These parameters are guaranteed by design and characterization; not production tested.
- $t_{DON}/t_{DOFF}/t_R/t_F$ are defined in Figure 24.
- Output discharge path is enabled during device off.

Typical Performance Characteristics

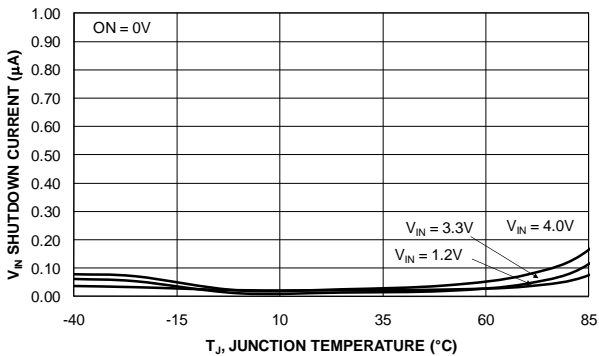

Figure 7. Shutdown Current vs. Temperature

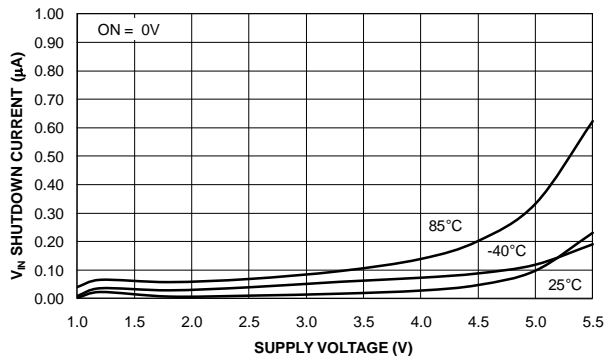

Figure 8. Shutdown Current vs. Supply Voltage

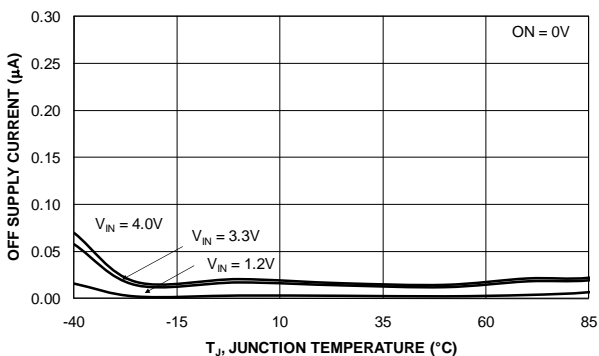

Figure 9. Off Supply Current vs. Temperature (FPF1205, V_{OUT} Floating)

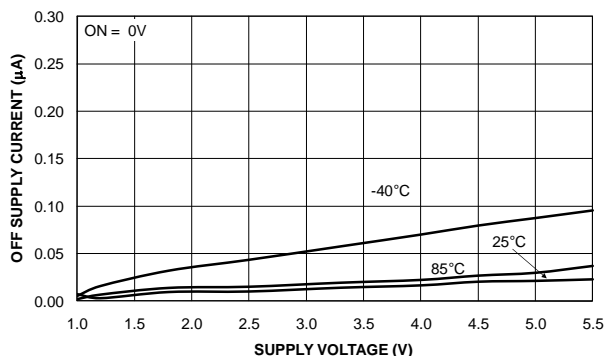

Figure 10. Off Supply Current vs. Supply Voltage (FPF1205, V_{OUT} Floating)

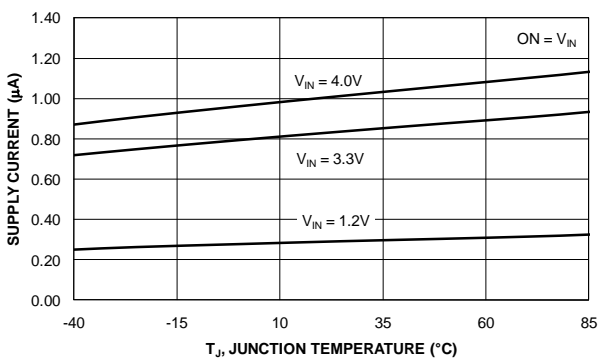

Figure 11. Quiescent Current vs. Temperature

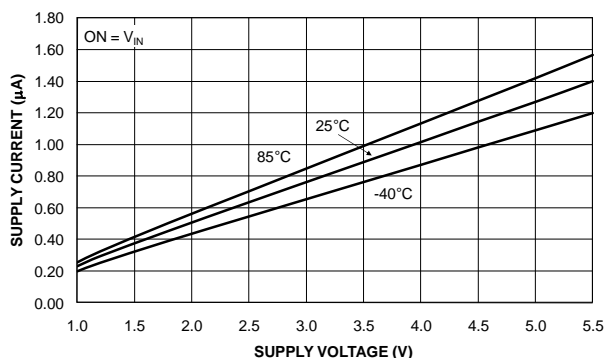

Figure 12. Quiescent Current vs. Supply Voltage

Typical Performance Characteristics

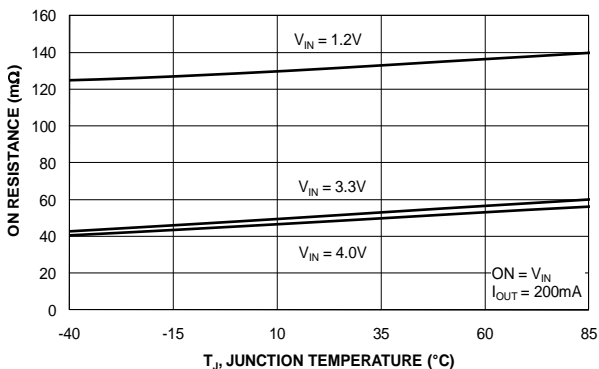

Figure 13. R_{ON} vs. Temperature

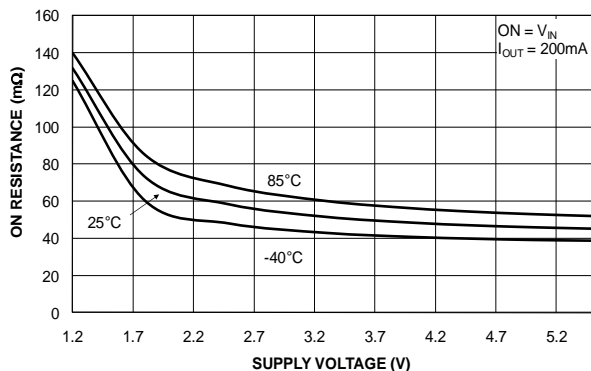

Figure 14. R_{ON} vs. Supply Voltage

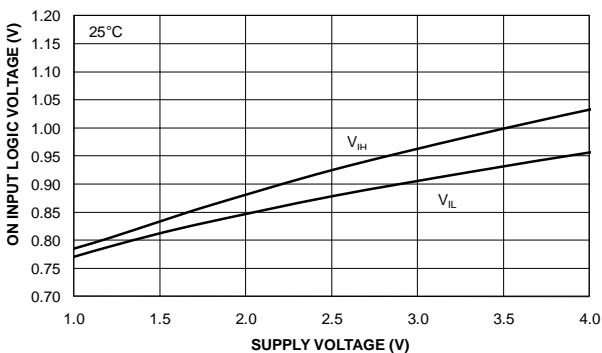

Figure 15. ON-Pin Threshold vs. V_{IN}

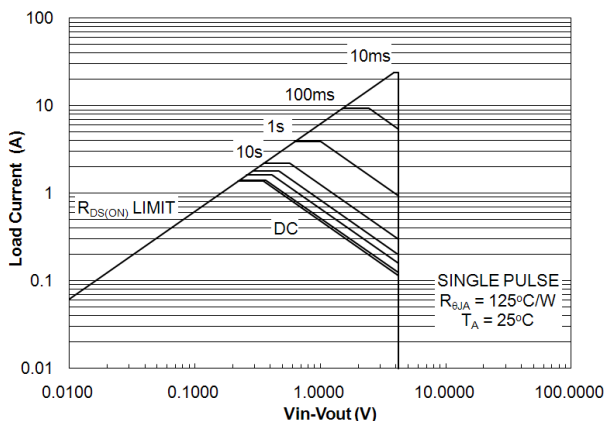

Figure 16. Load Current vs. $V_{IN}-V_{OUT}$

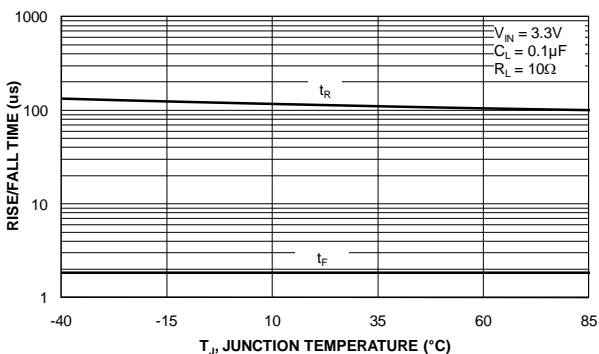

Figure 17. V_{OUT} Rise and Fall Time vs. Temperature at $R_L=10\ \Omega$

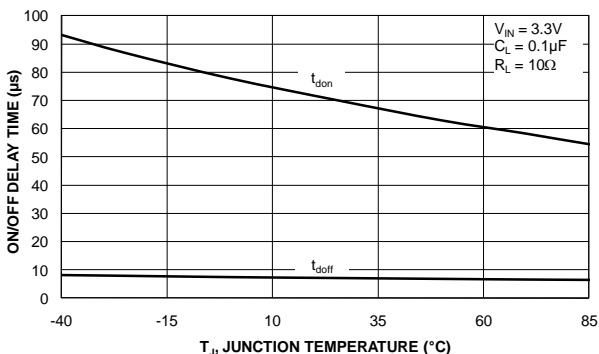

Figure 18. V_{OUT} Turn-On and Turn-Off Delay vs. Temperature at $R_L=10\ \Omega$

Typical Performance Characteristics

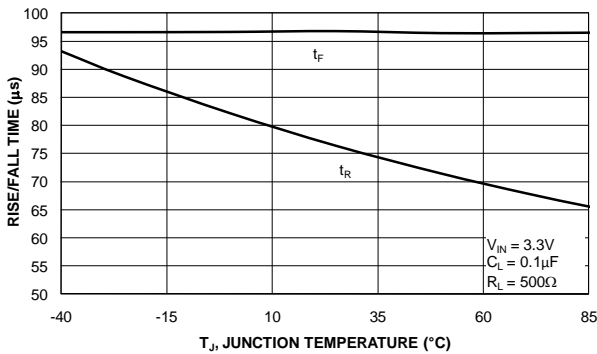

Figure 19. V_{OUT} Rise and Fall Time vs. Temperature at $R_L=500 \Omega$

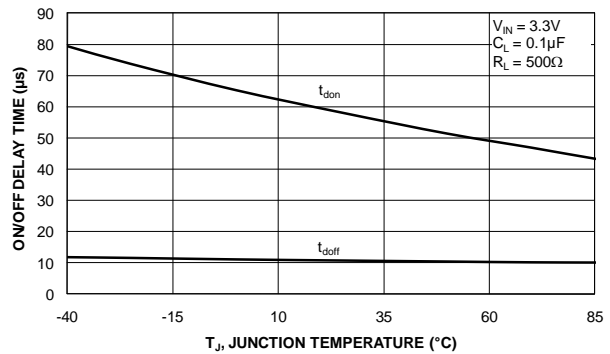

Figure 20. V_{OUT} Turn-On and Turn-Off Delay vs. Temperature at $R_L=500 \Omega$

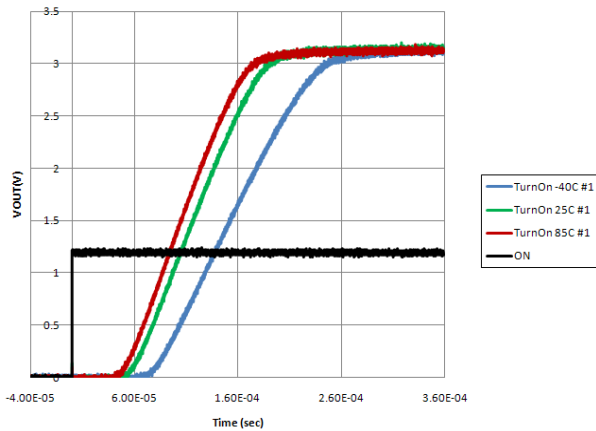

Figure 21. Turn-On Response ($V_{IN}=3.3 \text{ V}$, $C_{IN}=1 \mu\text{F}$, $C_{OUT}=0.1 \mu\text{F}$, $R_L=10 \Omega$)

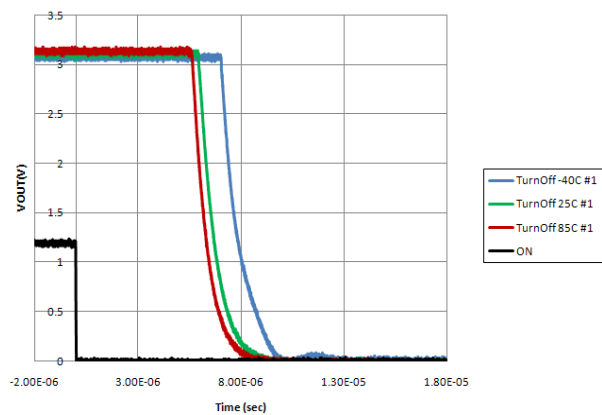

Figure 22. Turn-Off Response ($V_{IN}=3.3 \text{ V}$, $C_{IN}=1 \mu\text{F}$, $C_{OUT}=0.1 \mu\text{F}$, $R_L=10 \Omega$)

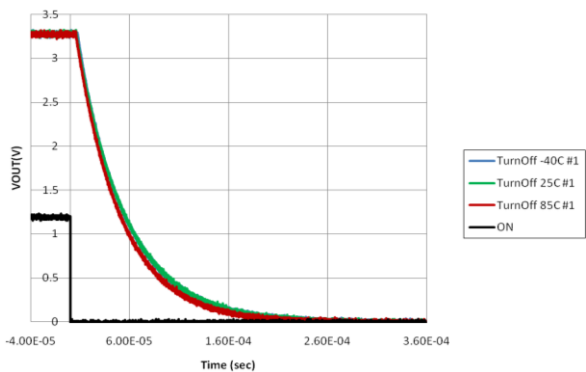

Figure 23. Turn-Off Response (FPF1205 = No Output Pull-Down Resistor) ($V_{IN}=3.3 \text{ V}$, $C_{IN}=1 \mu\text{F}$, $C_{OUT}=0.1 \mu\text{F}$, $R_L=500 \Omega$)

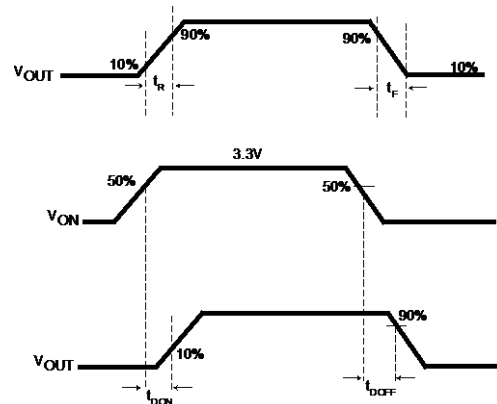

Figure 24. Timing Diagram

- Notes:
8. $t_{ON}=t_R + t_{DON}$.
 9. $t_{OFF}=t_F + t_{DOFF}$.

Operation and Application Description

The FPF1205 and FPF1206 are low- R_{ON} P-channel load switches with controlled turn-on. The core of each device is a 50 m Ω P-channel MOSFET and controller capable of functioning over a wide input operating range of 1.2 - 4.0 V. The ON pin, an active HIGH GIOP / CMOS-compatible input, controls the state of the switch.

The FPF1206 contains a 65 Ω on-chip load resistor for quick output discharge when the switch is turned off.

Input Capacitor

To limit the voltage drop on the input supply caused by transient inrush current when the switch turns on into a discharged load capacitor or short-circuit, a capacitor must be placed between the V_{IN} and GND pins. A 1 μ F ceramic capacitor, C_{IN} , placed close to the pins is usually sufficient. Higher-value C_{IN} can be used to reduce the voltage drop in higher-current applications.

Output Capacitor

A 0.1 μ F capacitor, C_{OUT} , should be placed between the V_{OUT} and GND pins. This capacitor prevents parasitic

board inductance from forcing V_{OUT} below GND when the switch is on. C_{IN} greater than C_{OUT} is highly recommended. C_{OUT} greater than C_{IN} can cause V_{OUT} to exceed V_{IN} when the system supply is removed. This could result in current flow through the body diode from V_{OUT} to V_{IN} .

Board Layout

For best performance, all traces should be as short as possible. To be most effective, the input and output capacitors should be placed close to the device to minimize the effect that parasitic trace inductance may have on normal and short-circuit operation. Using wide traces or large copper planes for all pins (V_{IN} , V_{OUT} , ON, and GND) helps minimize the parasitic electrical effects along with minimizing the case ambient thermal impedance. However, the V_{OUT} pin of FPF1206 should not connect directly the battery source due to the discharge mechanism of the load switch.

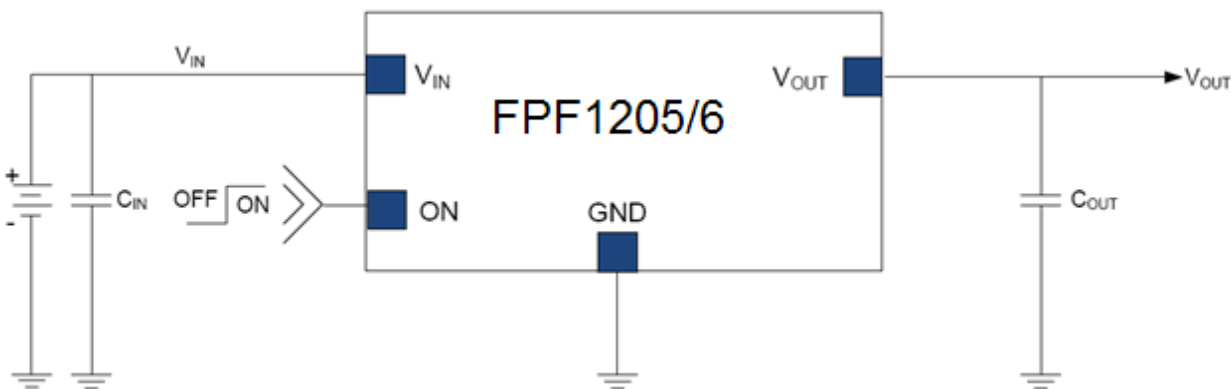
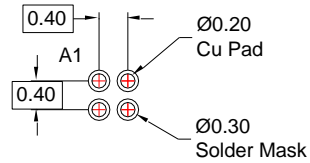
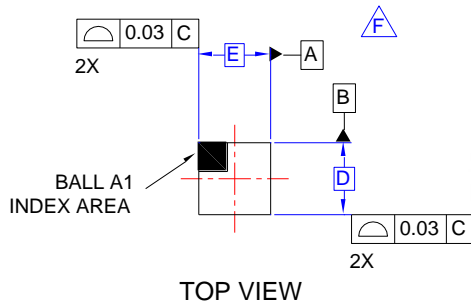
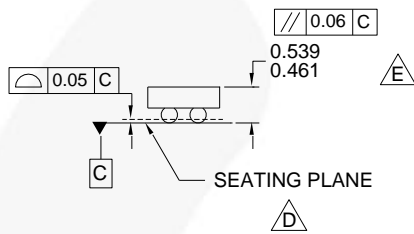

Figure 25. Typical Application

Physical Dimensions



RECOMMENDED LAND PATTERN
(NSMD PAD TYPE)



SIDE VIEWS

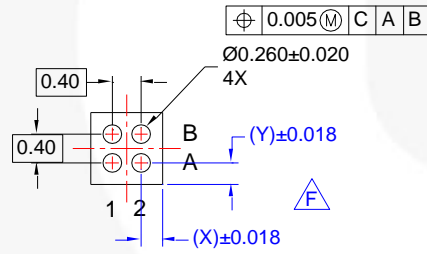
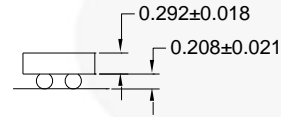

BOTTOM VIEW

NOTES:

- A. NO JEDEC REGISTRATION APPLIES.
- B. DIMENSIONS ARE IN MILLIMETERS.
- C. DIMENSIONS AND TOLERANCE PER ASME Y14.5M, 1994.
- D. DATUM C IS DEFINED BY THE SPHERICAL CROWNS OF THE BALLS.
- E. PACKAGE NOMINAL HEIGHT IS 500 MICRONS ±39 MICRONS (461-539 MICRONS).
- F. FOR DIMENSIONS D, E, X, AND Y SEE PRODUCT DATASHEET.
- G. DRAWING FILNAME: MKT-UC004AFrev1.

Figure 26. 4 Ball, 0.76 x 0.76 mm Wafer-Level Chip-Scale WLCSP Packaging

Product-Specific Dimensions

Product	D	E	X	Y
FPF1205UCX	760 μm ±30 μm	760 μm ±30 μm	0.180 mm ±0.018 μm	0.180 mm ±0.018 μm
FPF1206UCX	760 μm ±30 μm	760 μm ±30 μm	0.180 mm ±0.018 μm	0.180 mm ±0.018 μm

Package drawings are provided as a service to customers considering Fairchild components. Drawings may change in any manner without notice. Please note the revision and/or date on the drawing and contact a Fairchild Semiconductor representative to verify or obtain the most recent revision. Package specifications do not expand the terms of Fairchild's worldwide terms and conditions, specifically the warranty therein, which covers Fairchild products. Always visit Fairchild Semiconductor's online packaging area for the most recent package drawing: <http://www.fairchildsemi.com/packaging/>.



TRADEMARKS

The following includes registered and unregistered trademarks and service marks, owned by Fairchild Semiconductor and/or its global subsidiaries, and is not intended to be an exhaustive list of all such trademarks.

- | | | | |
|--------------------------|--|---------------------------------------|------------------|
| 2Cool™ | FPS™ | | Sync-Lock™ |
| AccuPower™ | F-PFS™ | PowerTrench® | SYSTEM GENERAL® |
| AX-CAP®* | FRFET® | PowerXS™ | TinyBoost™ |
| BitSiC™ | Global Power Resource™ | Programmable Active Droop™ | TinyBuck™ |
| Build it Now™ | GreenBridge™ | QFET® | TinyCalc™ |
| CorePLUS™ | Green FPS™ | QS™ | TinyLogic® |
| CorePOWER™ | Green FPS™ e-Series™ | Quiet Series™ | TINYOPTO™ |
| CROSSVOLT™ | Gmax™ | RapidConfigure™ | TinyPower™ |
| CTL™ | GTO™ | | TinyPWM™ |
| Current Transfer Logic™ | IntelliMAX™ | Saving our world, 1mW/W/kW at a time™ | TinyWire™ |
| DEUXPEED® | ISOPLANAR™ | SignalWise™ | TranSiC™ |
| Dual Cool™ | Making Small Speakers Sound Louder and Better™ | SmartMax™ | TriFault Detect™ |
| EcoSPARK® | MegaBuck™ | SMART START™ | TRUECURRENT®* |
| EfficientMax™ | MICROCOUPLER™ | Solutions for Your Success™ | μSerDes™ |
| ESBC™ | MicroFET™ | SPM® | SerDes® |
| Fairchild® | MicroPak™ | STEALTH™ | UHC® |
| Fairchild Semiconductor® | MicroPak2™ | SuperFET® | Ultra FRFET™ |
| FACT Quiet Series™ | MillerDrive™ | SuperSOT™-3 | UniFET™ |
| FACT® | MotionMax™ | SuperSOT™-6 | VCX™ |
| FAST® | mWSaver™ | SuperSOT™-8 | VisualMax™ |
| FastvCore™ | OptoHiT™ | SupreMOS® | VoltagePlus™ |
| FETBench™ | OPTOLOGIC® | SyncFET™ | XS™ |
| | OPTOPLANAR® | | |

* Trademarks of System General Corporation, used under license by Fairchild Semiconductor.

DISCLAIMER

FAIRCHILD SEMICONDUCTOR RESERVES THE RIGHT TO MAKE CHANGES WITHOUT FURTHER NOTICE TO ANY PRODUCTS HEREIN TO IMPROVE RELIABILITY, FUNCTION, OR DESIGN. FAIRCHILD DOES NOT ASSUME ANY LIABILITY ARISING OUT OF THE APPLICATION OR USE OF ANY PRODUCT OR CIRCUIT DESCRIBED HEREIN; NEITHER DOES IT CONVEY ANY LICENSE UNDER ITS PATENT RIGHTS, NOR THE RIGHTS OF OTHERS. THESE SPECIFICATIONS DO NOT EXPAND THE TERMS OF FAIRCHILD'S WORLDWIDE TERMS AND CONDITIONS, SPECIFICALLY THE WARRANTY THEREIN, WHICH COVERS THESE PRODUCTS.

LIFE SUPPORT POLICY

FAIRCHILD'S PRODUCTS ARE NOT AUTHORIZED FOR USE AS CRITICAL COMPONENTS IN LIFE SUPPORT DEVICES OR SYSTEMS WITHOUT THE EXPRESS WRITTEN APPROVAL OF FAIRCHILD SEMICONDUCTOR CORPORATION.

As used herein:

1. Life support devices or systems are devices or systems which, (a) are intended for surgical implant into the body or (b) support or sustain life, and (c) whose failure to perform when properly used in accordance with instructions for use provided in the labeling, can be reasonably expected to result in a significant injury of the user.
2. A critical component in any component of a life support, device, or system whose failure to perform can be reasonably expected to cause the failure of the life support device or system, or to affect its safety or effectiveness.

ANTI-COUNTERFEITING POLICY

Fairchild Semiconductor Corporation's Anti-Counterfeiting Policy. Fairchild's Anti-Counterfeiting Policy is also stated on our external website, www.fairchildsemi.com, under Sales Support.

Counterfeiting of semiconductor parts is a growing problem in the industry. All manufacturers of semiconductor products are experiencing counterfeiting of their parts. Customers who inadvertently purchase counterfeit parts experience many problems such as loss of brand reputation, substandard performance, failed applications, and increased cost of production and manufacturing delays. Fairchild is taking strong measures to protect ourselves and our customers from the proliferation of counterfeit parts. Fairchild strongly encourages customers to purchase Fairchild parts either directly from Fairchild or from Authorized Fairchild Distributors who are listed by country on our web page cited above. Products customers buy either from Fairchild directly or from Authorized Fairchild Distributors are genuine parts, have full traceability, meet Fairchild's quality standards for handling and storage and provide access to Fairchild's full range of up-to-date technical and product information. Fairchild and our Authorized Distributors will stand behind all warranties and will appropriately address any warranty issues that may arise. Fairchild will not provide any warranty coverage or other assistance for parts bought from Unauthorized Sources. Fairchild is committed to combat this global problem and encourage our customers to do their part in stopping this practice by buying direct or from authorized distributors.

PRODUCT STATUS DEFINITIONS

Definition of Terms

Datasheet Identification	Product Status	Definition
Advance Information	Formative / In Design	Datasheet contains the design specifications for product development. Specifications may change in any manner without notice.
Preliminary	First Production	Datasheet contains preliminary data; supplementary data will be published at a later date. Fairchild Semiconductor reserves the right to make changes at any time without notice to improve design.
No Identification Needed	Full Production	Datasheet contains final specifications. Fairchild Semiconductor reserves the right to make changes at any time without notice to improve the design.
Obsolete	Not In Production	Datasheet contains specifications on a product that is discontinued by Fairchild Semiconductor. The datasheet is for reference information only.

Rev. 164

ON Semiconductor and  are trademarks of Semiconductor Components Industries, LLC dba ON Semiconductor or its subsidiaries in the United States and/or other countries. ON Semiconductor owns the rights to a number of patents, trademarks, copyrights, trade secrets, and other intellectual property. A listing of ON Semiconductor's product/patent coverage may be accessed at www.onsemi.com/site/pdf/Patent-Marking.pdf. ON Semiconductor reserves the right to make changes without further notice to any products herein. ON Semiconductor makes no warranty, representation or guarantee regarding the suitability of its products for any particular purpose, nor does ON Semiconductor assume any liability arising out of the application or use of any product or circuit, and specifically disclaims any and all liability, including without limitation special, consequential or incidental damages. Buyer is responsible for its products and applications using ON Semiconductor products, including compliance with all laws, regulations and safety requirements or standards, regardless of any support or applications information provided by ON Semiconductor. "Typical" parameters which may be provided in ON Semiconductor data sheets and/or specifications can and do vary in different applications and actual performance may vary over time. All operating parameters, including "Typicals" must be validated for each customer application by customer's technical experts. ON Semiconductor does not convey any license under its patent rights nor the rights of others. ON Semiconductor products are not designed, intended, or authorized for use as a critical component in life support systems or any FDA Class 3 medical devices or medical devices with a same or similar classification in a foreign jurisdiction or any devices intended for implantation in the human body. Should Buyer purchase or use ON Semiconductor products for any such unintended or unauthorized application, Buyer shall indemnify and hold ON Semiconductor and its officers, employees, subsidiaries, affiliates, and distributors harmless against all claims, costs, damages, and expenses, and reasonable attorney fees arising out of, directly or indirectly, any claim of personal injury or death associated with such unintended or unauthorized use, even if such claim alleges that ON Semiconductor was negligent regarding the design or manufacture of the part. ON Semiconductor is an Equal Opportunity/Affirmative Action Employer. This literature is subject to all applicable copyright laws and is not for resale in any manner.

PUBLICATION ORDERING INFORMATION

LITERATURE FULFILLMENT:

Literature Distribution Center for ON Semiconductor
19521 E. 32nd Pkwy, Aurora, Colorado 80011 USA
Phone: 303-675-2175 or 800-344-3860 Toll Free USA/Canada
Fax: 303-675-2176 or 800-344-3867 Toll Free USA/Canada
Email: orderlit@onsemi.com

N. American Technical Support: 800-282-9855 Toll Free
USA/Canada
Europe, Middle East and Africa Technical Support:
Phone: 421 33 790 2910
Japan Customer Focus Center
Phone: 81-3-5817-1050

ON Semiconductor Website: www.onsemi.com
Order Literature: <http://www.onsemi.com/orderlit>
For additional information, please contact your local
Sales Representative